

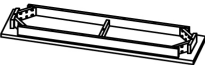

ASSEMBLY INSTRUCTIONS

SM1250-SM1270

PARTS CHECK LIST

Thank you for purchasing this product. It has been designed for assembly so please follow the assembly instruction below

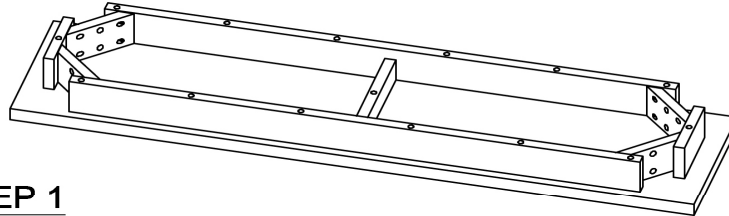

No.	Part name	Qty.
1		1
2		4



STEP 1

Put the top of product on clean, smooth, flat surface.

HARDWARE

No.	Description		Qty.
	Photo	Specification	
1		Bolts 5/16" *50mm Lock washer 5/16" Flat washer 5/16"	8
2		4x60mm	1

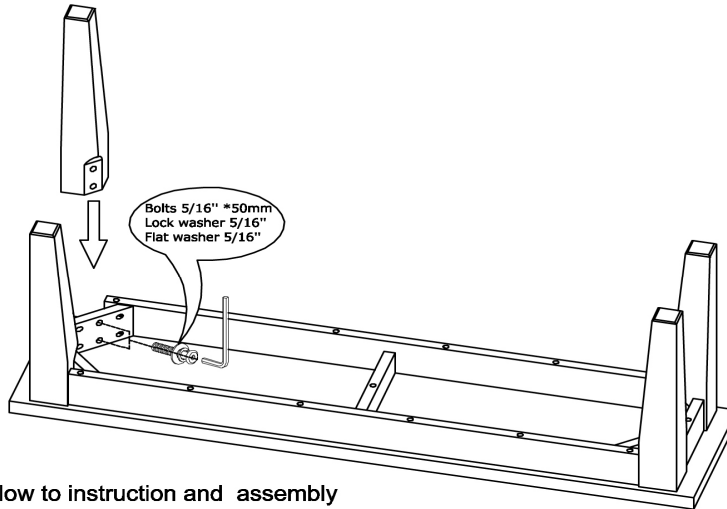

STEP 2

Attach the the leg follow to instruction and assembly all the bolts.

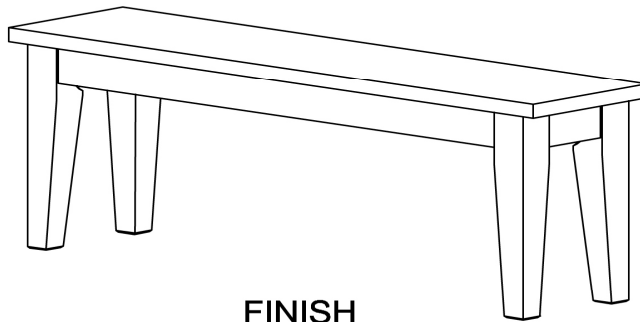

FINISH

Draw name :	Assembly Instruction	Designer / Drawer :	Lộc	Code :	QT03BM06
Item :	D136-41	Confirm by customer :		Effective date :	Sep. 29. 2011
Pages :	1 / 1				